

Faculté des arts et des sciences
Département de chimie

Surface Plasmon Resonance (SPR) Spectroscopy

Theory, Instrumentation & Applications

Antonella Badia

antonella.badia@umontreal.ca

CHEM 634

McGill University

January 26, 2007

SPR Spectroscopy - Overview:

- ❖ The detection principle relies on an electron charge density wave phenomenon that arises at the surface of a metallic film when light is reflected at the film under specific conditions.
- ❖ Molecular adsorption/desorption events are measured as a change in the refractive index at the metal film surface (“sensing surface”).
- ❖ Advantages:
 - Label-free detection technique
 - Distinguishes surface-bound material from bulk material
 - Monitor molecular interactions in real-time (kinetics)
 - Highly-sensitive (Δd_{film} of $\sim 1\text{-}2 \text{ \AA}$ or nanograms of adsorbed mass)
 - Works in turbid or opaque samples

Biological Applications of SPR

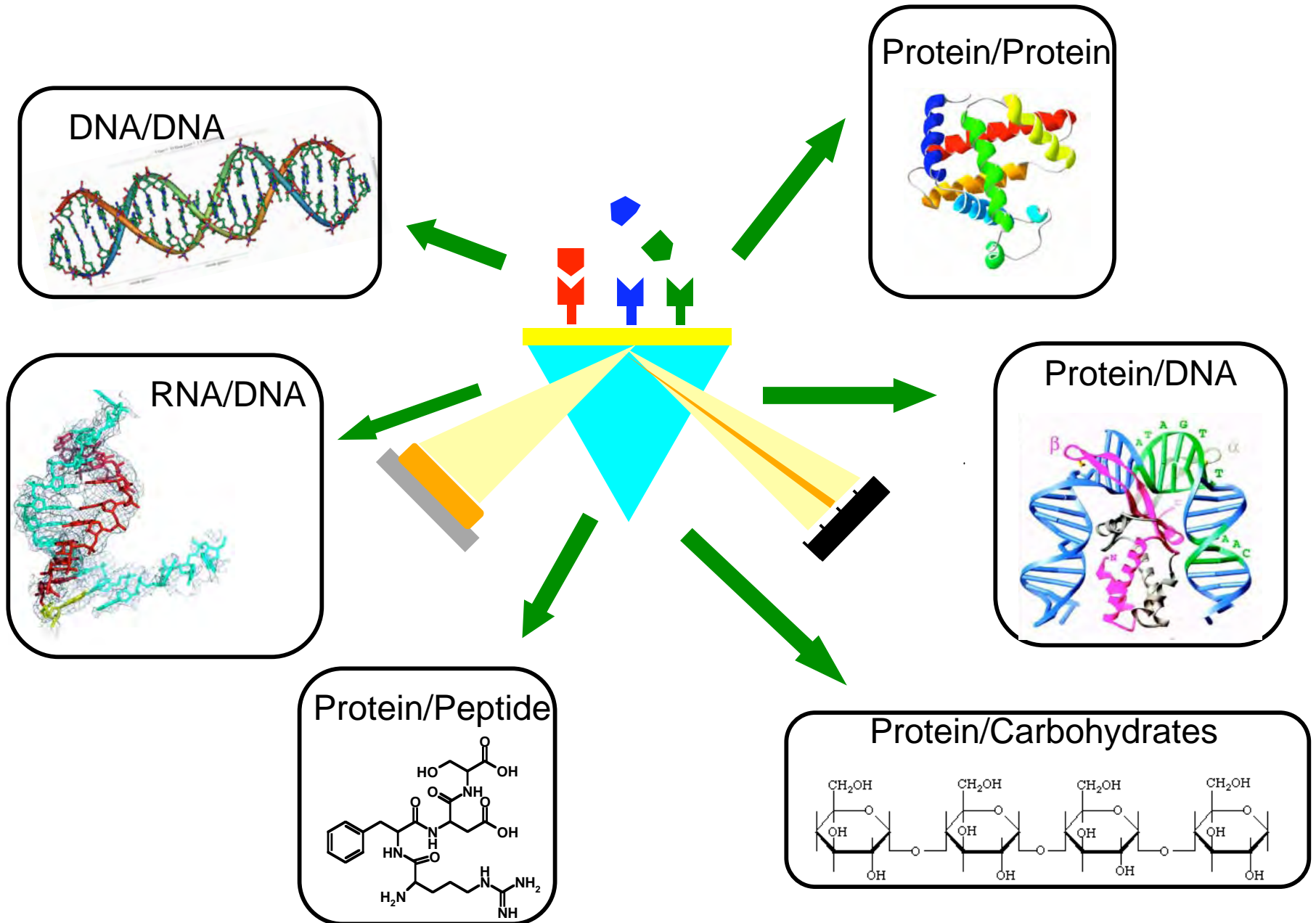

Basic Principle

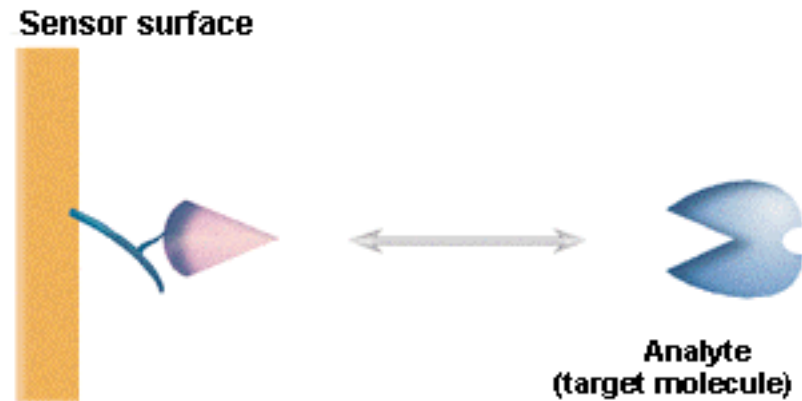

- A *binding molecule* is bound to the sensor surface (eg. a peptide)
- Another (*the analyte*) is passed over the surface and binds to it.

Other Areas of Application

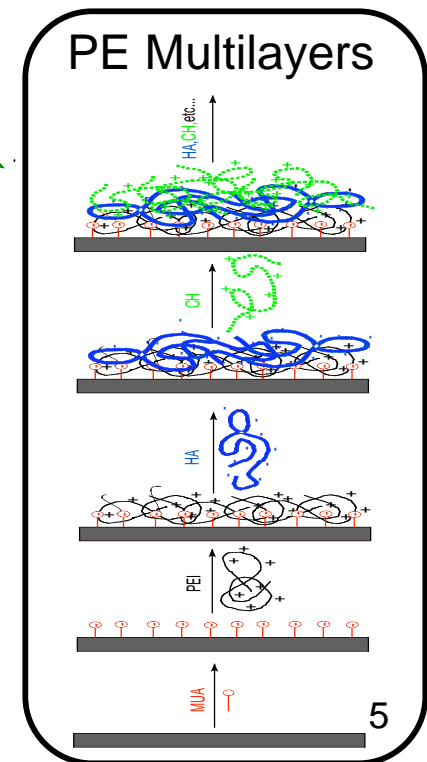
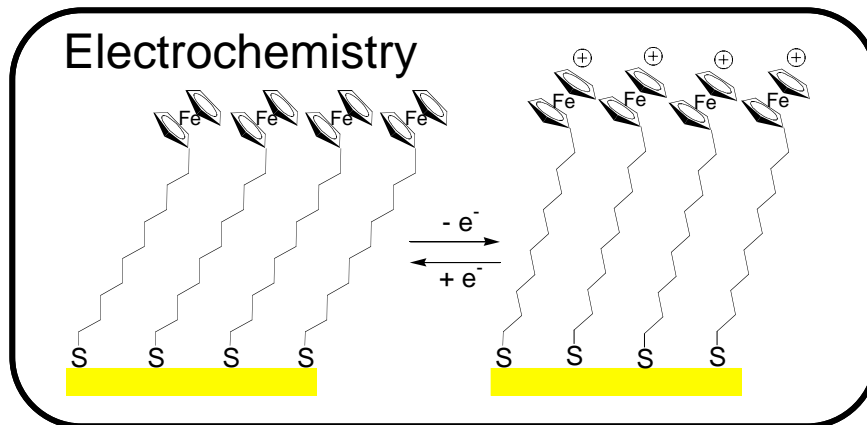
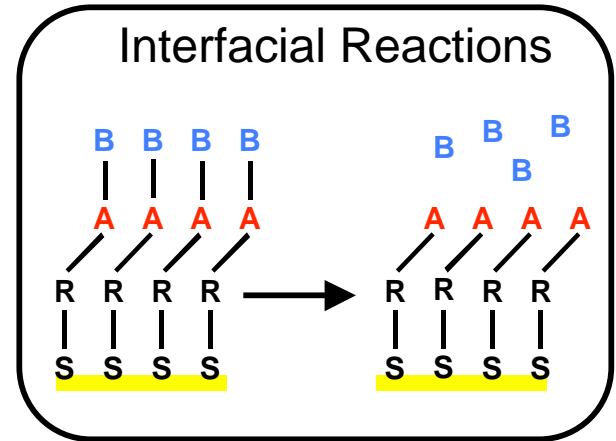
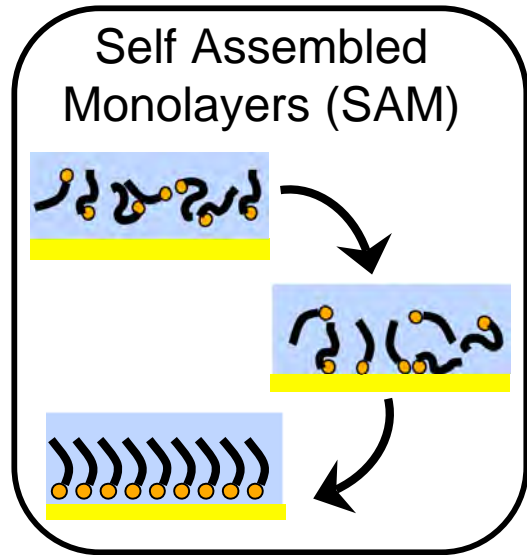

Surface plasmons

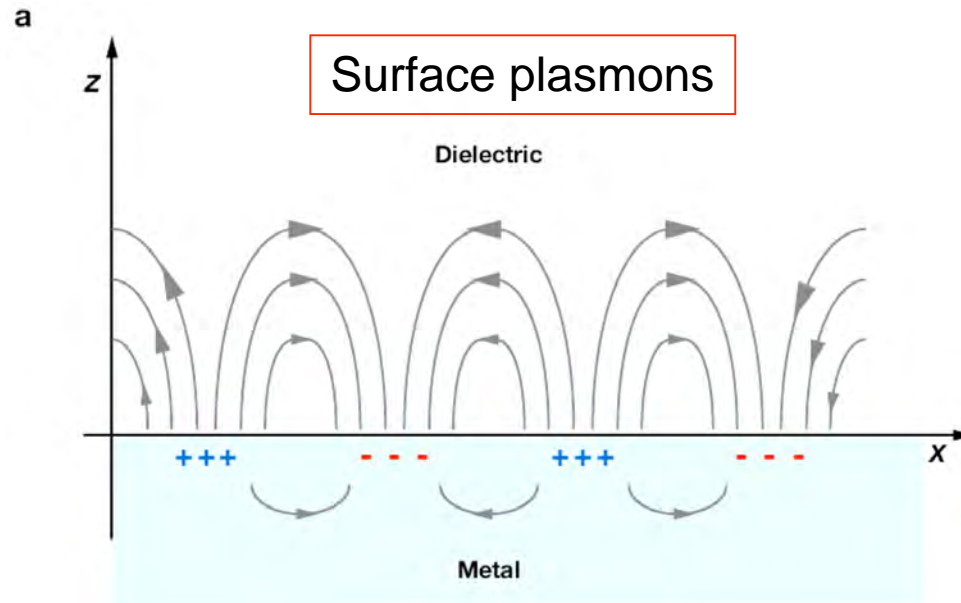

- ❖ Plasmons are collective charge density oscillations of the nearly free electron gas in a metal.
- ❖ Plasmons can be excited both in the bulk and on the surface of a metal.
- ❖ Surface plasmons or surface plasmon polaritons are surface electromagnetic waves that propagate parallel along a metal/dielectric interface.

Existence of electronic surface plasmons

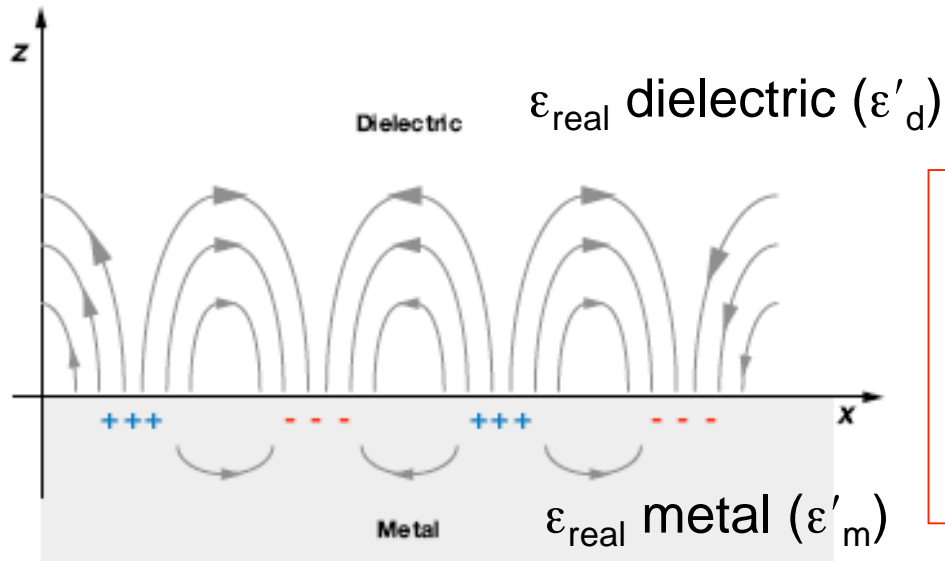

- ❖ Conditions to be met:
 - ❖ ϵ_{real} of the metal must be negative
 - ❖ $|\epsilon_{\text{real}}|$ of metal $>$ ϵ_{real} of dielectric

- ❖ Conditions are met in the IR-visible wavelength region for air/metal and water/metal interfaces (where ϵ'_m is negative and ϵ'_d of air or water is positive). Typical metals that support surface plasmons are silver and gold.

- ❖ Electronic surface plasmons obey the following dispersion relation:

$$k_{\text{SP}} = \frac{\omega}{c} \sqrt{\frac{\epsilon_d \epsilon_m}{\epsilon_d + \epsilon_m}}$$

SPR vs. LSPR

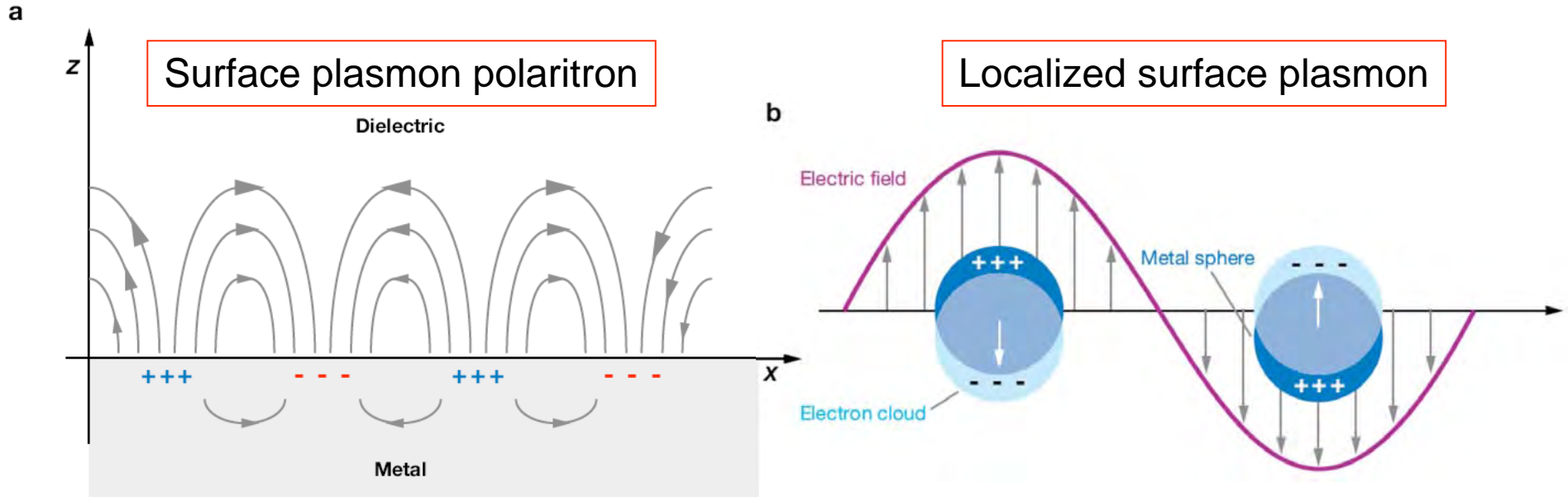

- ❖ The excitation of surface plasmons by light is denoted as:
 - ❖ surface plasmon resonance (SPR) for planar surfaces
 - ❖ localized surface plasmon resonance (LSPR) for nanometer-sized metallic structures.

Total Internal Reflection (TIR) phenomenon

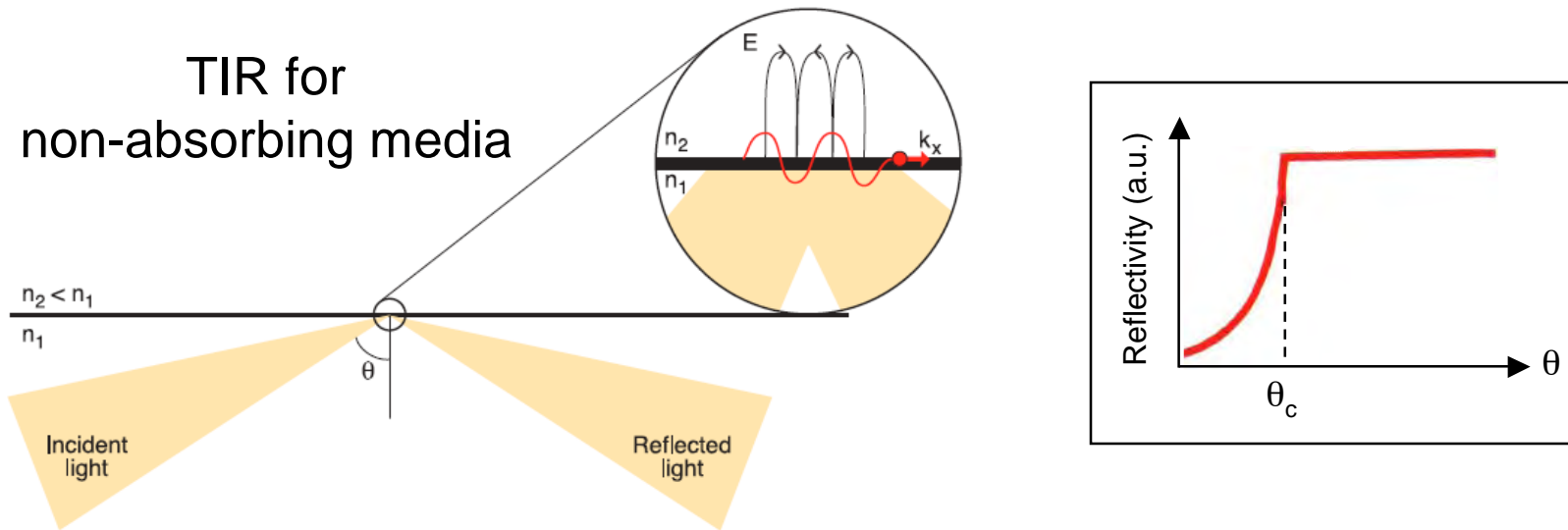

- ❖ The fully reflected beam leaks an electrical field intensity (i.e. evanescent field wave) into the low refractive index medium.
- ❖ No photons exit the reflecting surface but their electric field decreases exponentially with distance from the interface, decaying over a distance of $\sim 1/4$ wavelength beyond the surface.
- ❖ If the lower refractive index media has a non-zero absorption coefficient, the evanescent field wave may transfer the matching photon energy to the medium.

SPR phenomenon

TIR-interface coated
with a thin metal layer

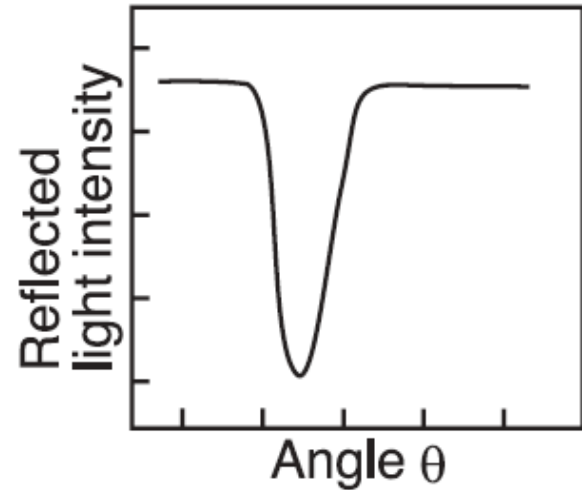
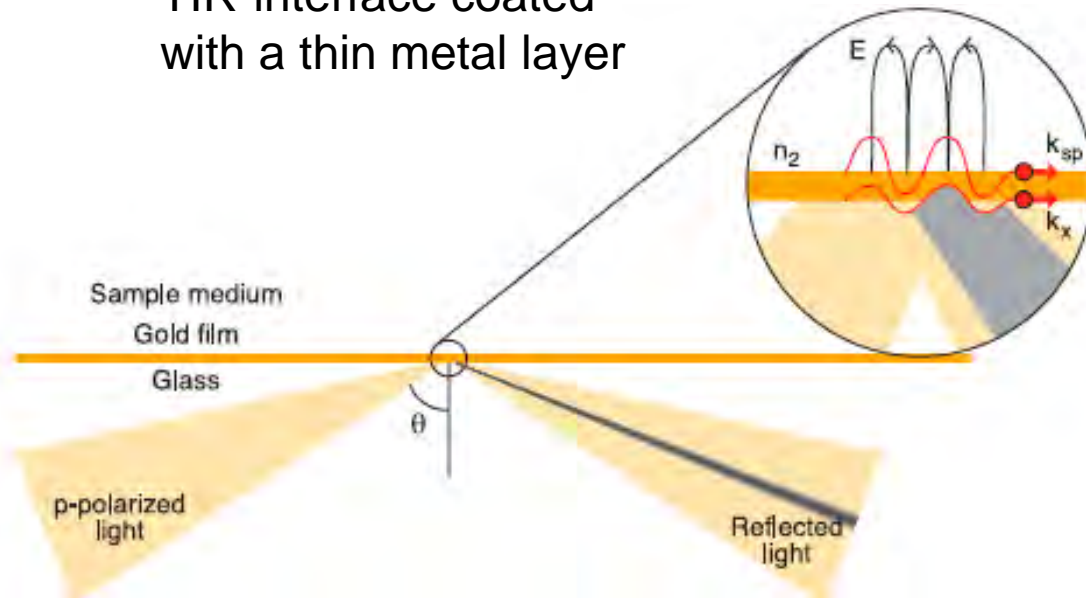

- ❖ Under specific conditions (i.e. incident angle of the light beam or wavelength), the electromagnetic field component of the p-polarized light penetrates the metal layer, and energy is transferred to the metal's electrons.
- ❖ This energy transfer produces surface plasmon polaritons at the metal-medium interface.
- ❖ As a result of the energy transfer, there is a decrease in the reflected light intensity (gray region) at a specific angle of incidence.

SPR-evanescent wave

- The surface plasmon wave propagates in the x- and y-directions along the metal-dielectric interface, for distances of ~ tens to hundreds of microns and decays evanescently in the z-direction (into the low refractive index medium) with 1/e decay lengths on the order of 200 nm.
- Due to its electromagnetic and surface propagating nature, the surface plasmon wave enhances the evanescent electric field amplitude.

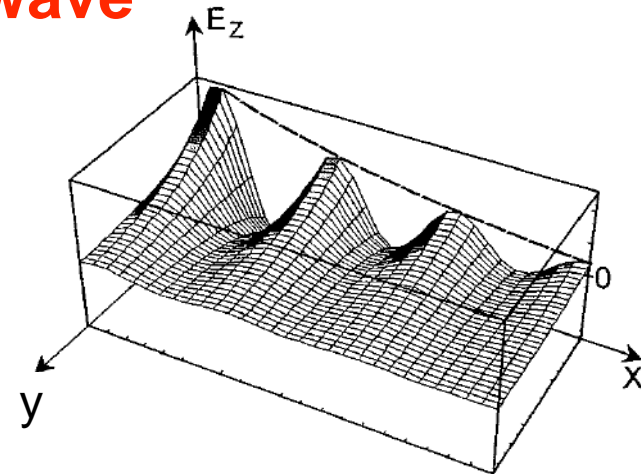

(SPR-evanescent wave)

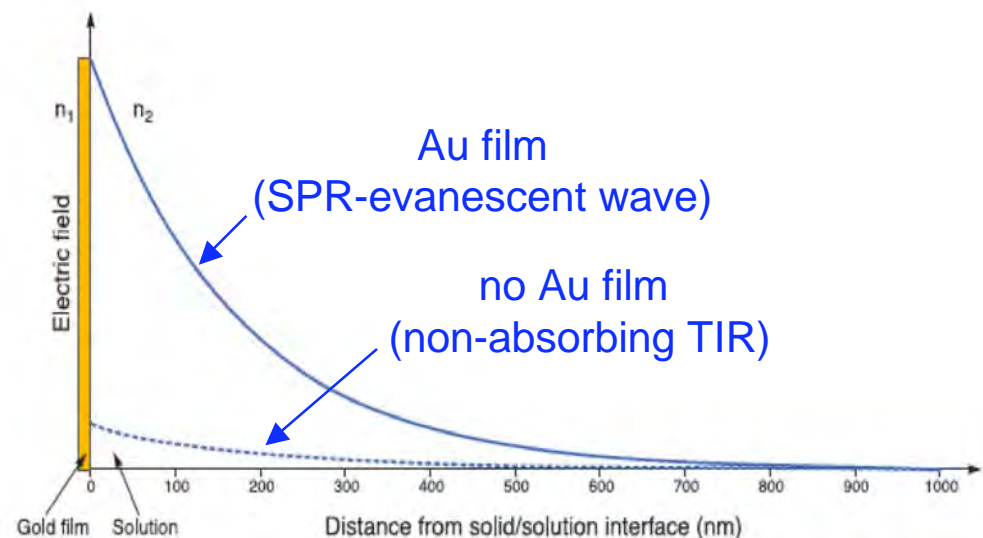

Characteristics of the SPR evanescent wave

Table 1

Major characteristics of surface plasma waves (SPW) at the metal–water interface^a

Metal layer supporting SPW	Gold	
Wavelength	$\lambda = 630$ nm	$\lambda = 850$ nm
Propagation length (μm)	3	24
Penetration depth into metal (nm)	29	25
Penetration depth into dielectric (nm)	162	400
Concentration of field in dielectric (%)	85	94

Surface plasmon excitation: energy and momentum matching

- For plasmon excitation by a photon to take place, the energy and momentum of these quantum-particles must both be conserved during the photon transformation into a plasmon.
- This requirement is met when the wavevector for the photon k_{ph} and plasmon k_{sp} are equal in magnitude and direction for the same frequency of the waves.
- Light falling directly on the metal-dielectric interface cannot couple into the surface plasmon since matching of both ω and k_x is not possible.
- For coupling to take place, the value of k_x of the incident light must be increased.

$$k_{sp} = \frac{\omega}{c} \sqrt{\frac{\epsilon_m \cdot \epsilon_d}{(\epsilon_m + \epsilon_d)}}$$

$$k_{ph} = \frac{\omega}{c} \cdot \sqrt{\epsilon_d}$$

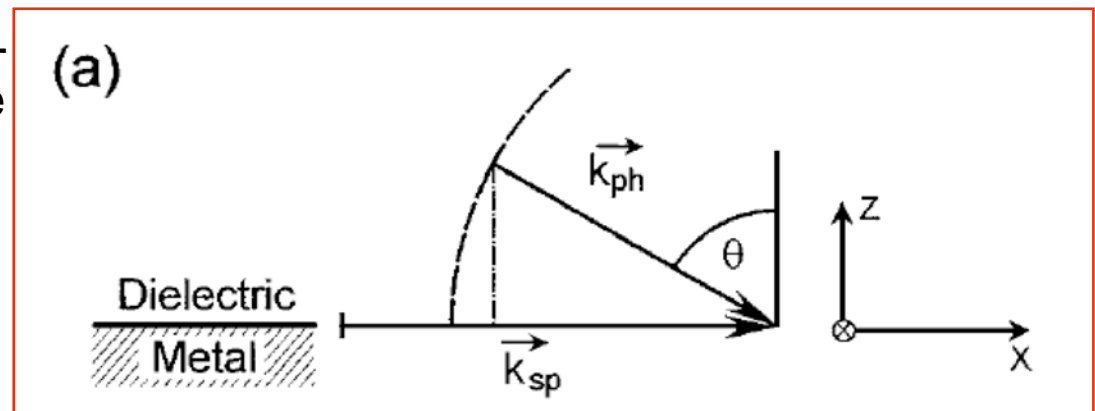

$$|\vec{k}_{ph}| < |\vec{k}_{sp}| \text{ (for all } \Theta) \quad 13$$

Surface plasmon excitation: prism couplers

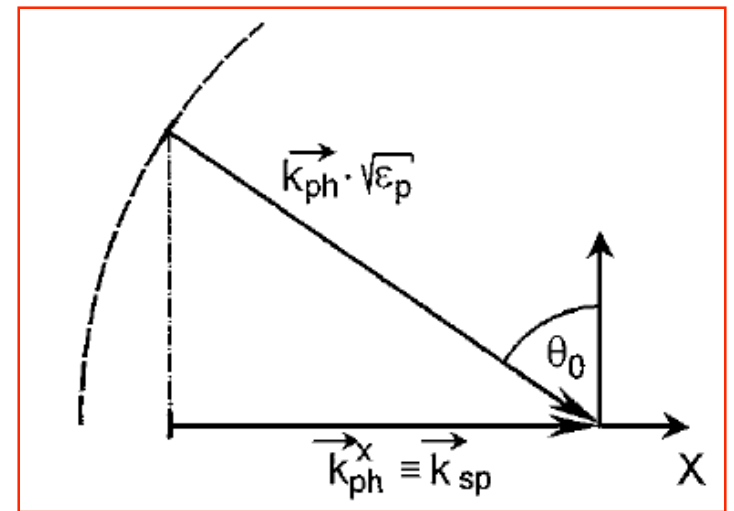
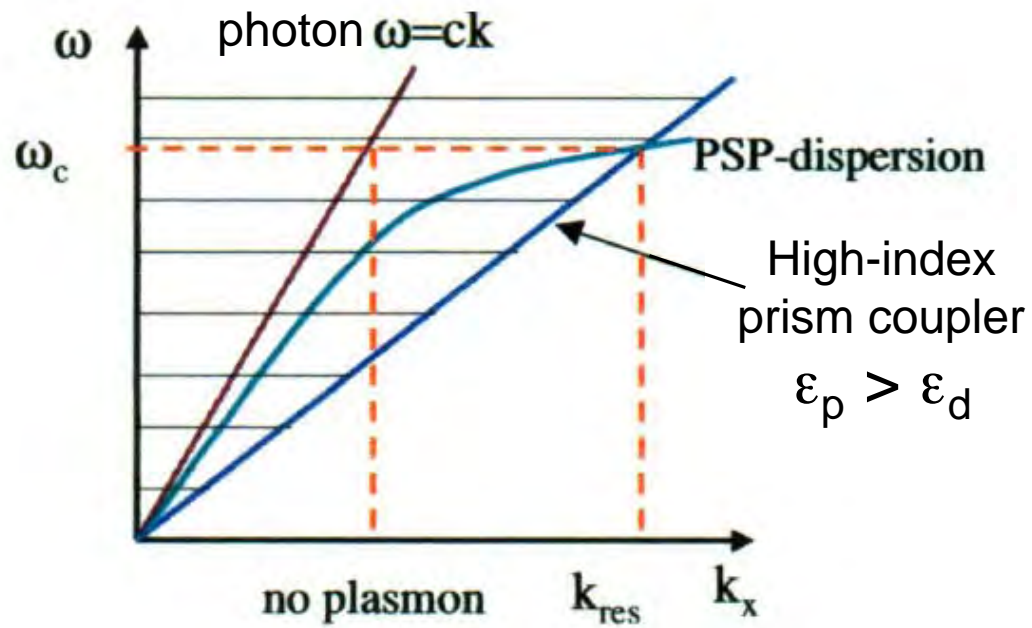

at the resonance angle θ_0

Effect of molecular adsorption/binding on SPR

- ❖ Because the plasmon electric field penetrates a short distance into the lower refractive index medium, the conditions for SPR are sensitive to the refractive index n at the metal-dielectric interface.
- ❖ A change in the bulk refractive index of the dielectric medium and the adsorption or desorption of molecules from the metal surface changes the refractive index at the metal-dielectric interface and results in a change in the velocity of the plasmons.
- ❖ This change in plasmon velocity alters the incident light vector required for SPR and minimum reflection.
- ❖ The exact position of resonance bears information on the interfacial mass coverage/thickness of the interfacial layer.

SPP excitation configurations

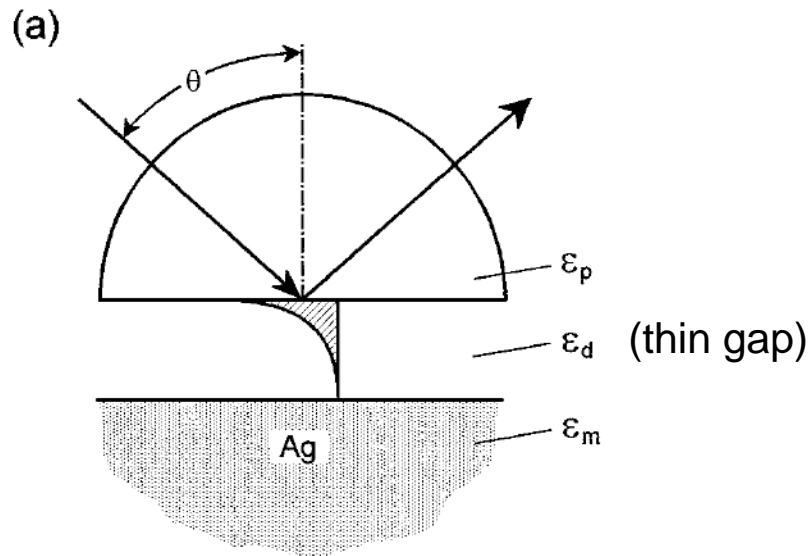

Otto configuration

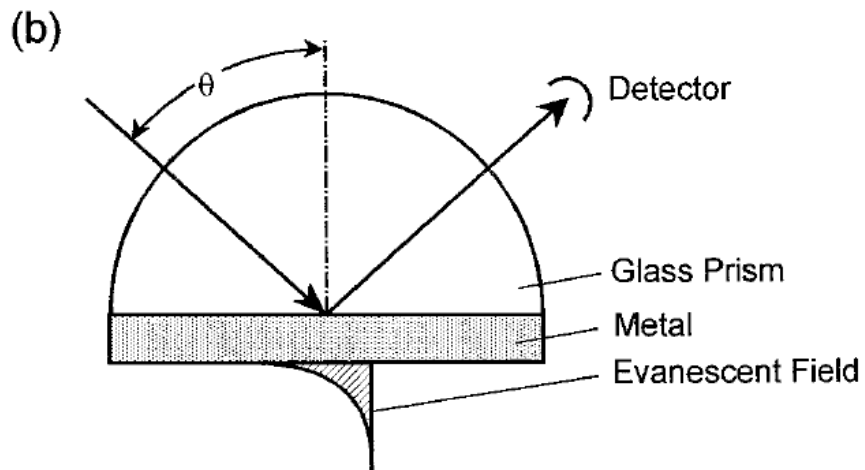

Kretschmann ATR configuration

SPR-based measurements

- Resonance angle shift
- Imaging/microscopy
- Wavelength shift (FT-SPR)

The aim of SPR instrumentation is to determine the resonance position as precisely as possible and with the best time resolution.

SPR-based measurements

- **Resonance angle shift**
- Imaging/microscopy
- Wavelength shift (FT-SPR)

Resonance angle shift measurements: principle

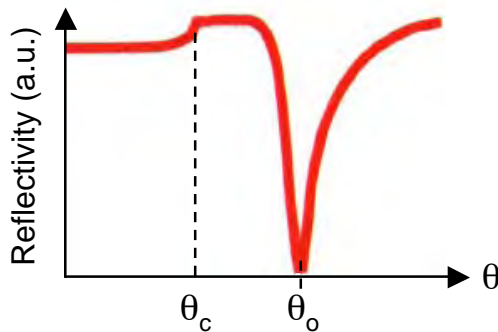
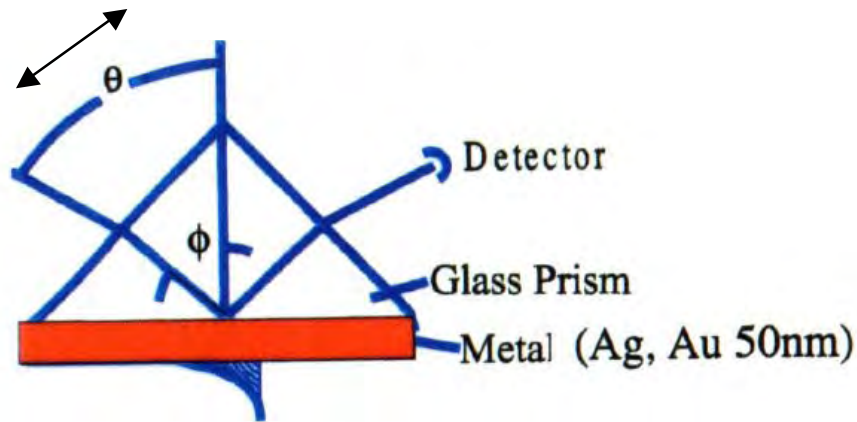

- Metal-coated high-refractive index prism (BK7, sapphire, LaSFN9, SF10, etc.)
- ATR/Kretschmann configuration
- Single wavelength p-polarized incident light
- The reflected light intensity is measured as a function of the angle of incidence Θ .
- The angle scan changes the wave-vector k_x of the incident light onto the prism base.

Angle-shift design 1

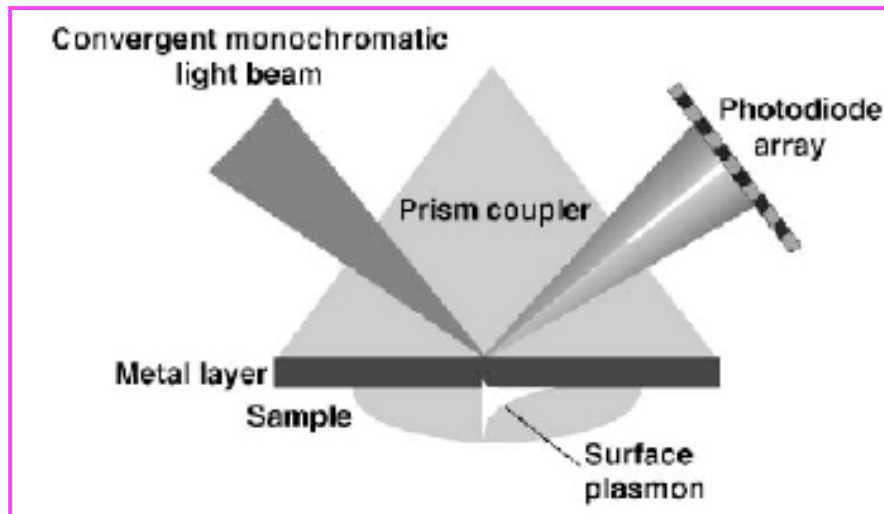

Commercial instruments:
Biacore, Reichert SR7000

- A lens is used to focus the light beam onto the prism base.
- Within the focus, a variety of angles of incidence are covered.
- The angle range (typically a few degrees) is given by the focal length of the lens and the beam diameter.
- The reflection curve is monitored by a PSD or a linear CCD array.
- An array scan of reflectivity vs. pixel number is obtained which cannot be modeled using Fresnel equations.

Angle-shift design 2

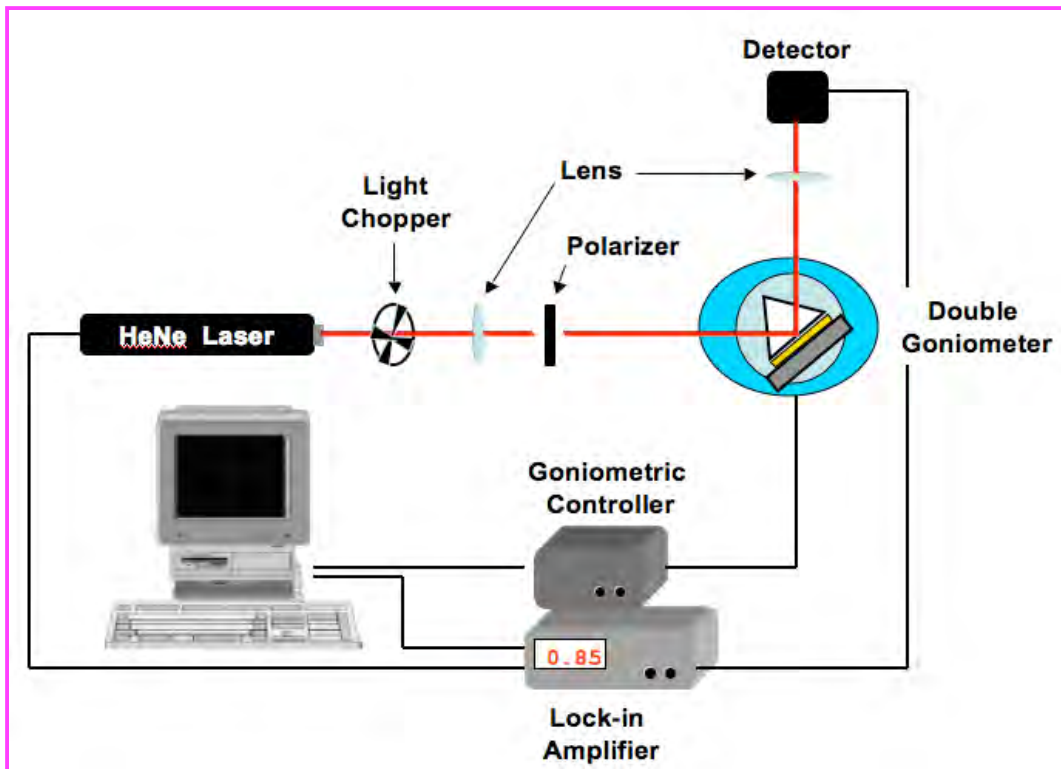

- The laser and detector arm are moved synchronously using a Θ - 2Θ goniometer and the reflected light intensity is measured as a function of the angle of incidence.
- The resulting reflectivity vs. incidence angle plot can be modeled using Fresnel equations.

Commercial instruments:
Biosuplar, Resonant Probes,
Optrel Multiskop

SPR angular reflectivity curve

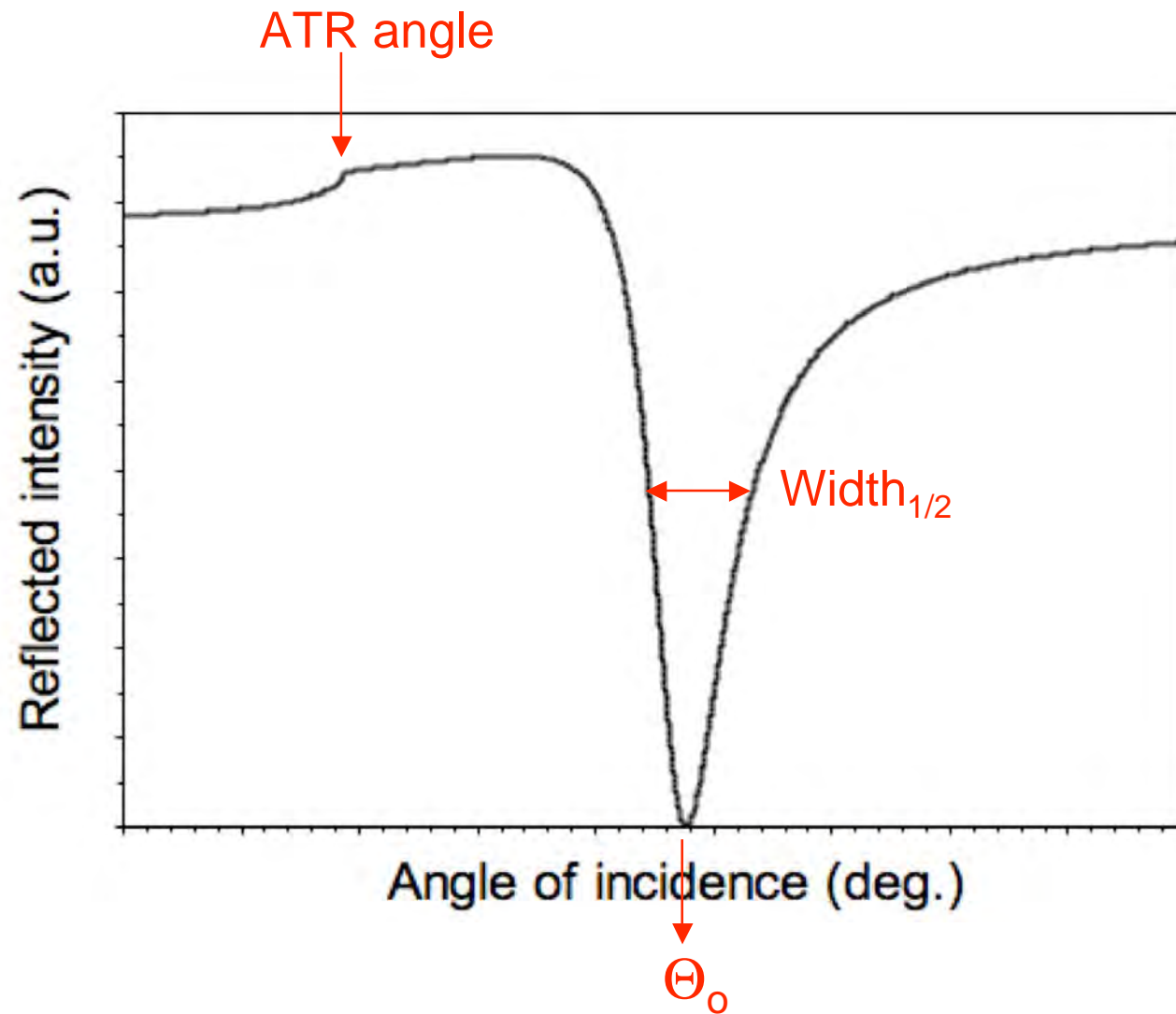

Surface interactions

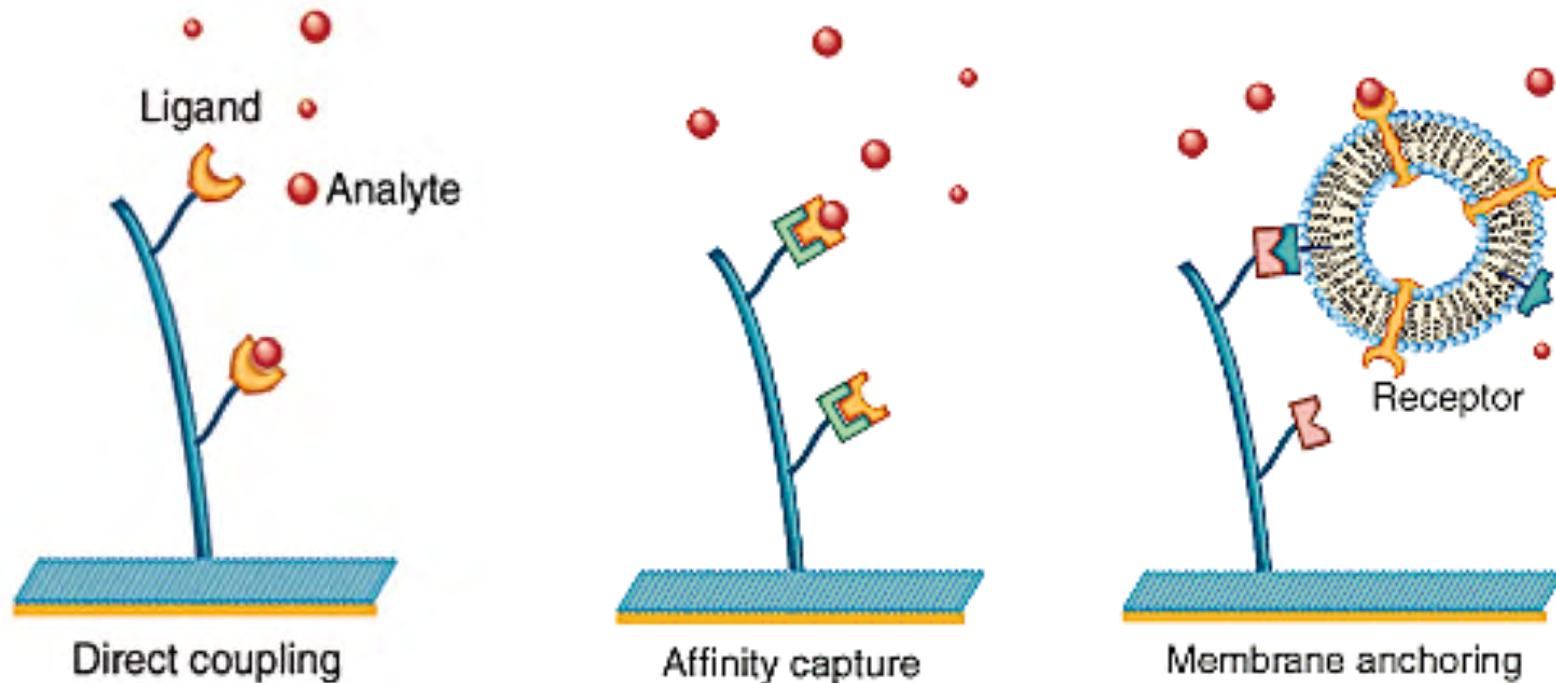

- Direct coupling of ligand (binding molecule) to surface
- Indirect, via a capture molecule (eg. a specific IgG)
- Membrane anchoring, where the interacting ligand is on the surface of a captured liposome

Fabrication of sensing surface

- ❖ Coat glass slides or prism with 45-50 nm of gold
- ❖ Surface Chemistry
 - ❖ Hydrophilic and hydrophobic surfaces
- ❖ Immobilize ligand
 - ❖ Direct coupling - attach ligand chemically via a linker
 - ❖ Capturing - attach a protein that binds your target

References: Jonsen et. al 1991 (Anal Biochem 198, 268-277);
O'Shannessy et. al., 1992 (Biochem 205, 132-136)

Ligand coupling chemistry

Allows covalent coupling via -NH_2 , -SH , -CHO & -COOH groups:

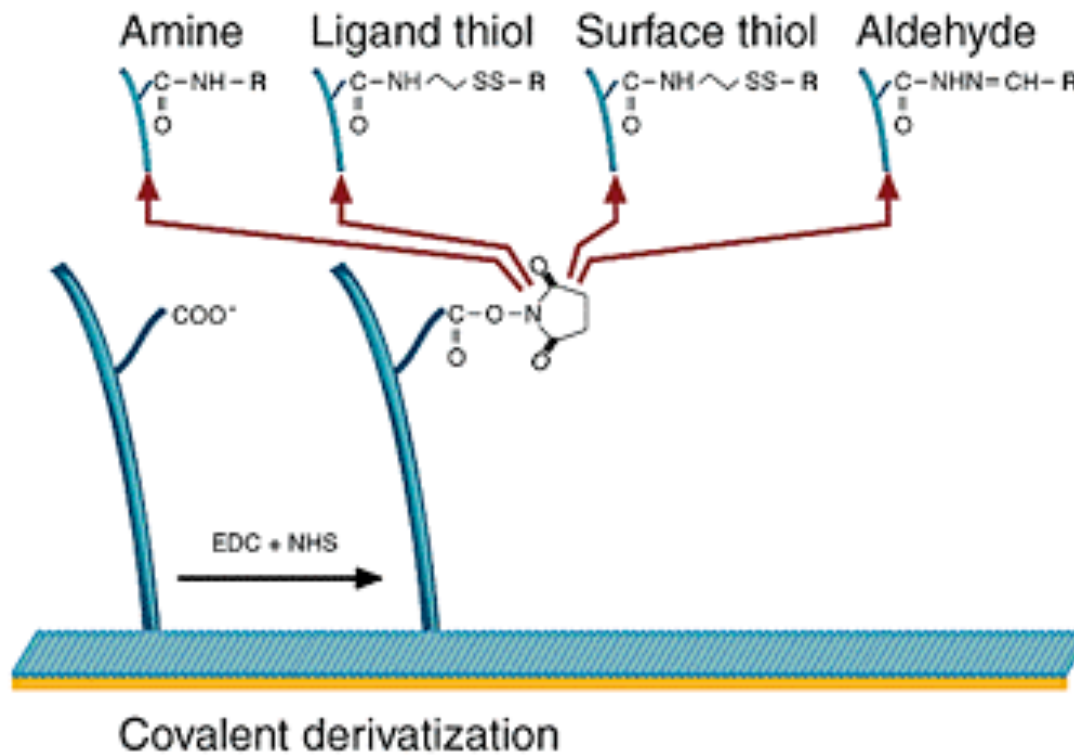

Molecular adsorption and angle shift

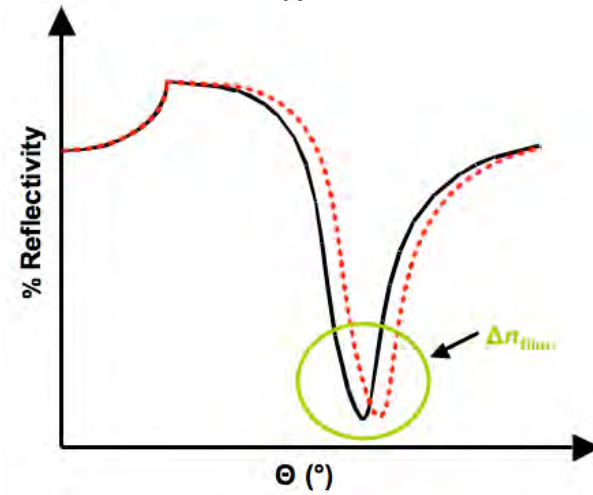
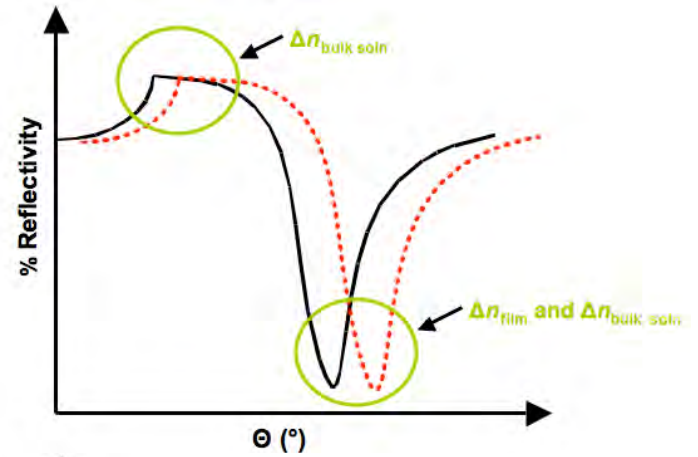
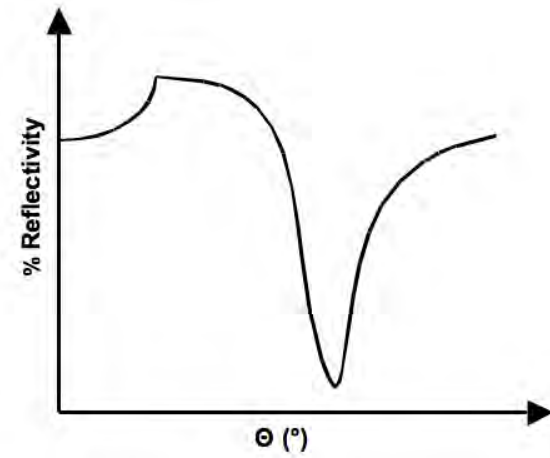
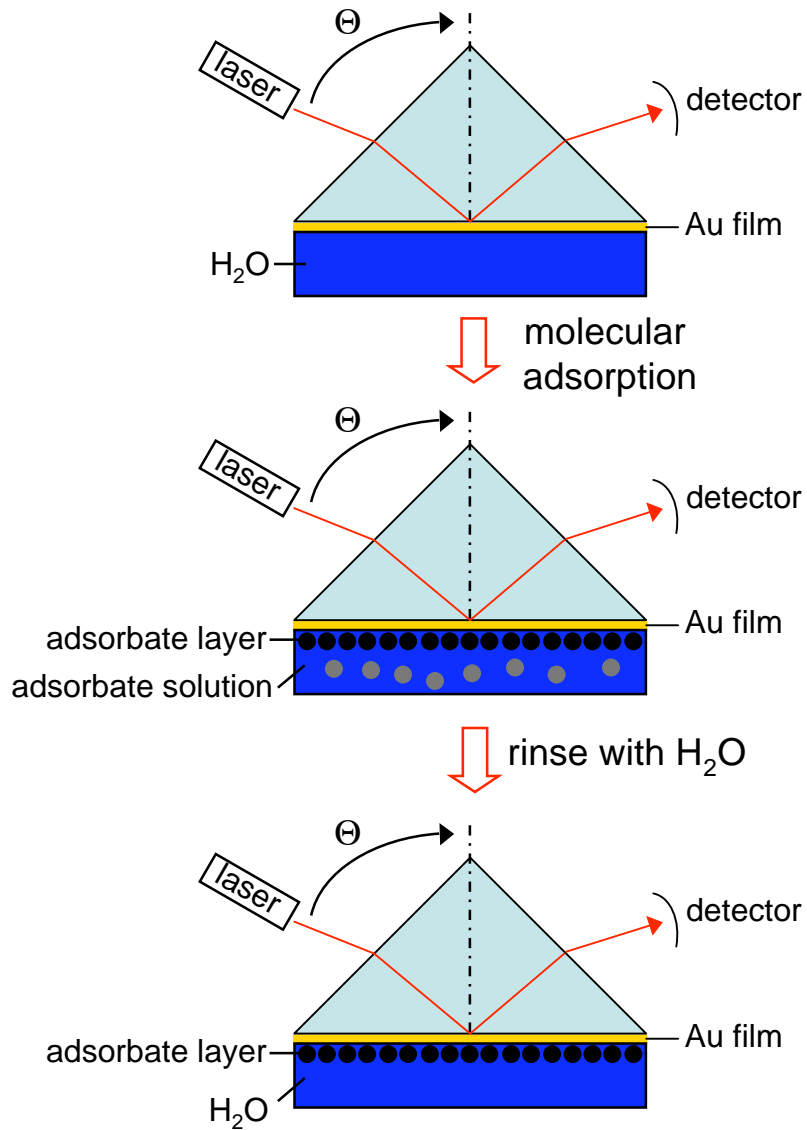

Monitoring molecular adsorption by SPR

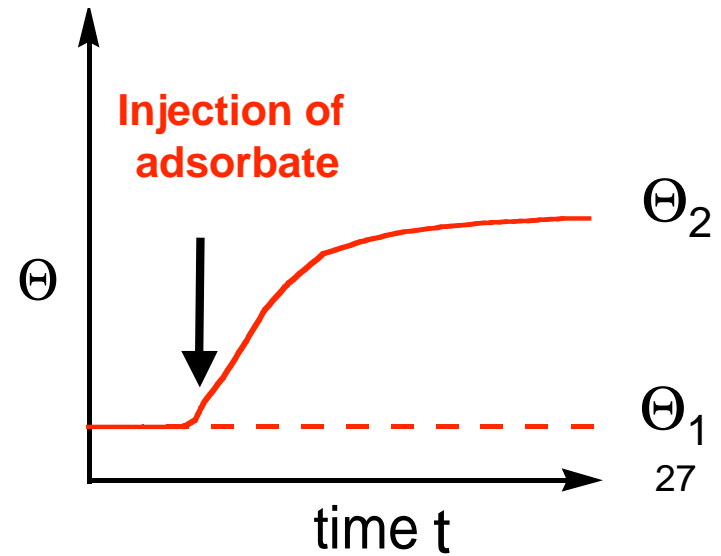
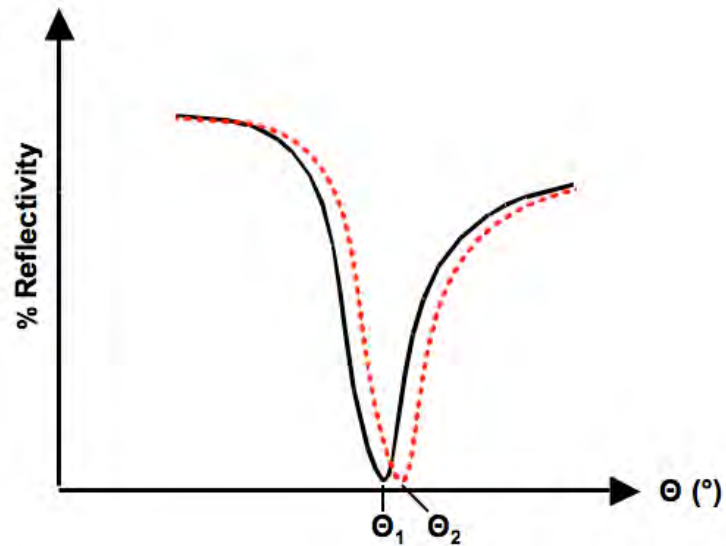
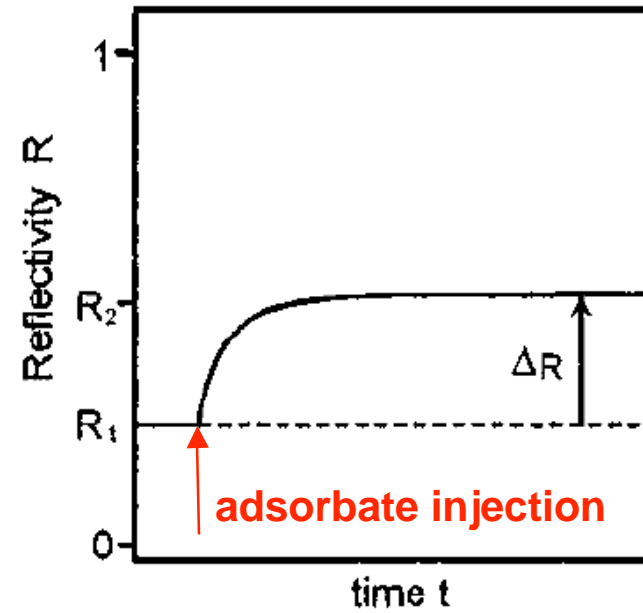
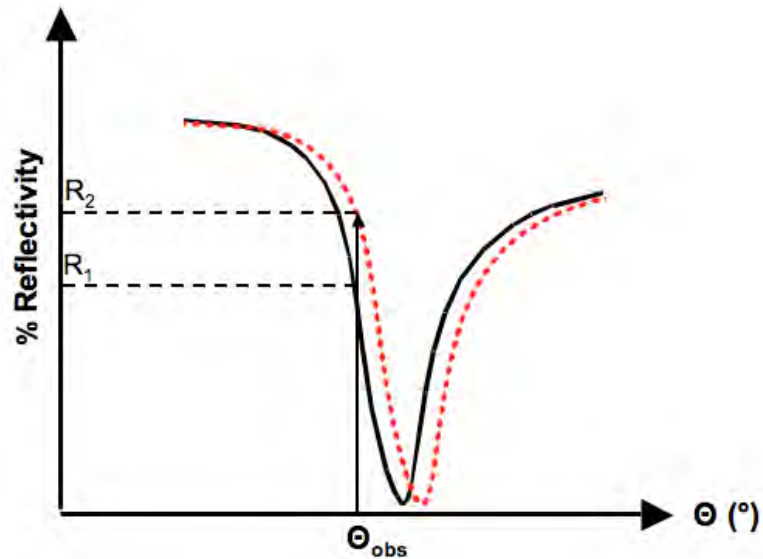

The sensorgram

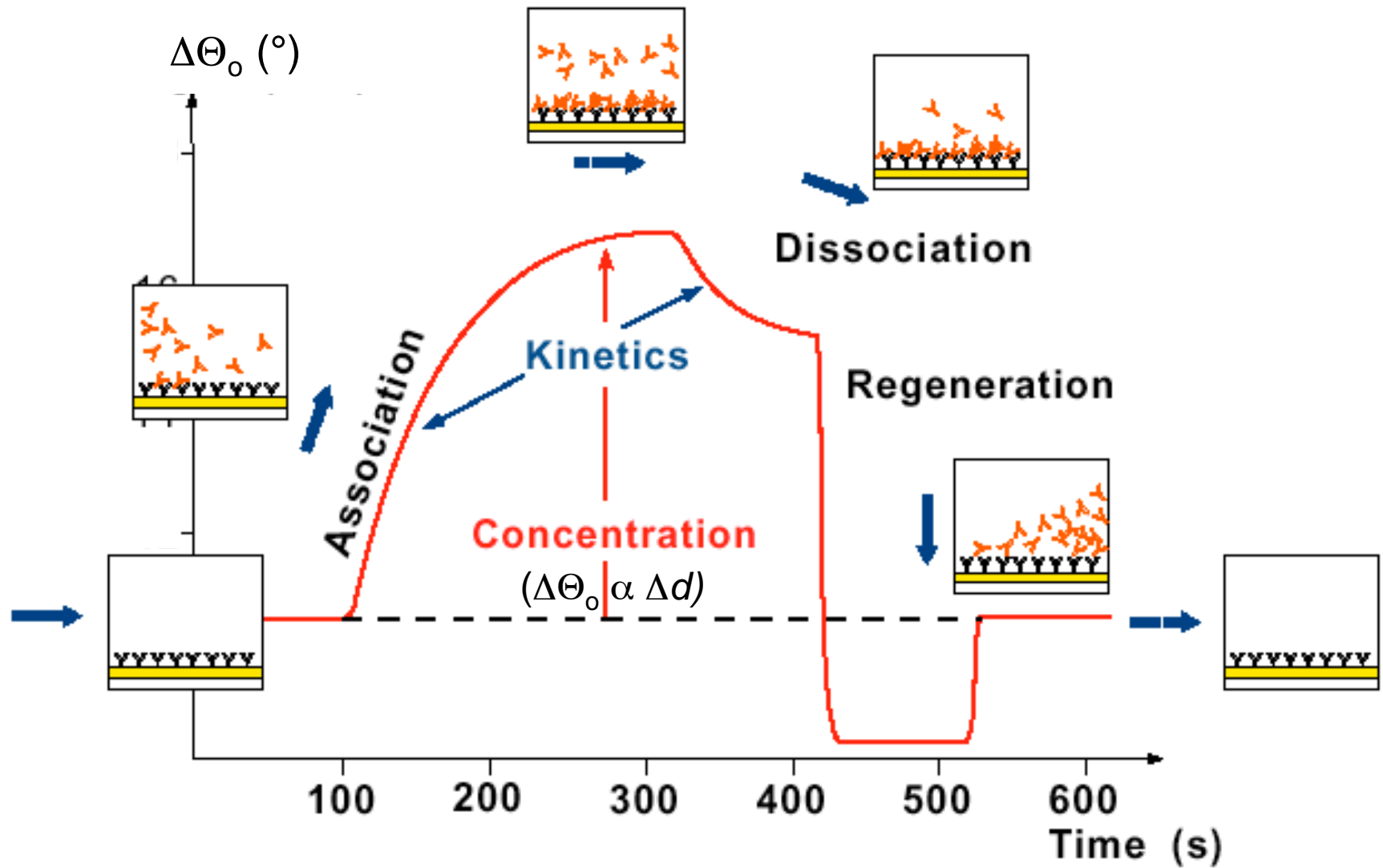

Sensorgrams for reversible and irreversible adsorption

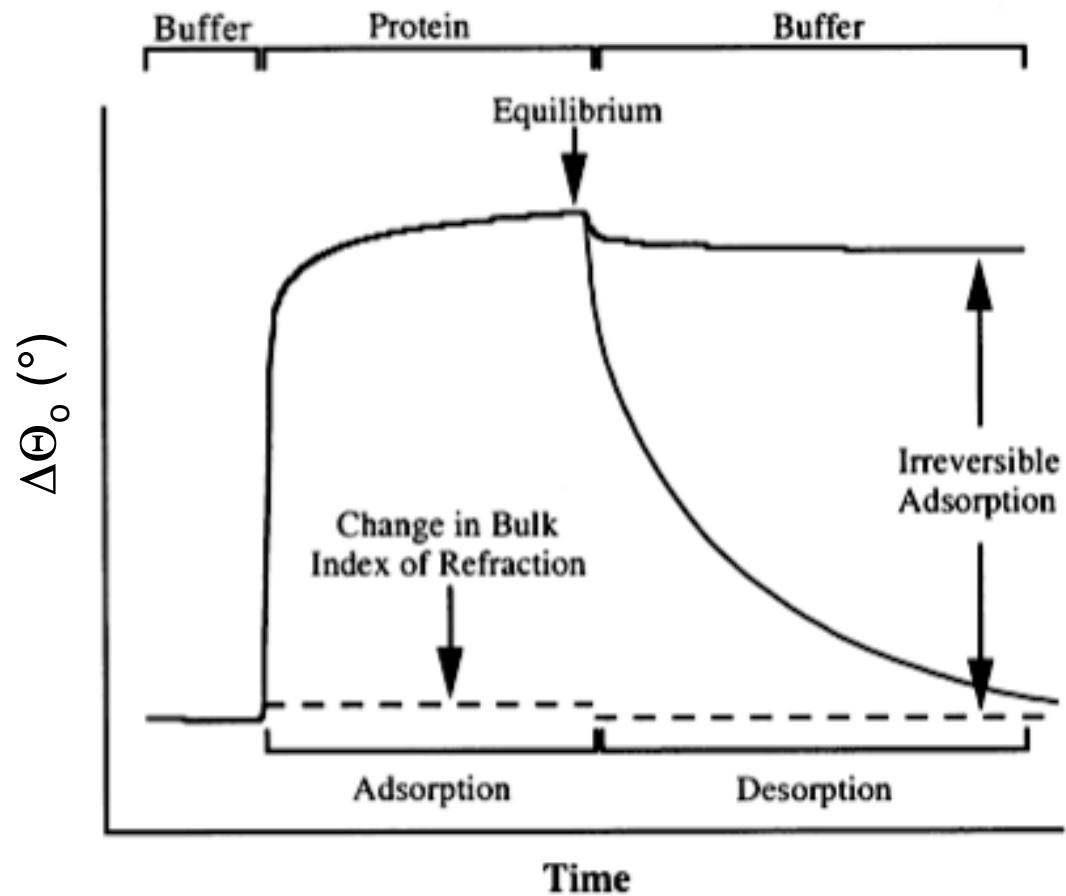

Analysis of SPR sensorgram

- How much? *Active surface or bulk concentration*
- How fast? *Kinetics*
- How strong? *Affinity*
- How specific? *Specificity*

Surface concentration

- Resonance angle change is proportional to mass change (mass of bound material).
- The change in surface refractive index is essentially the same for a given mass concentration change (allows mass/concentration deductions to be made).
- Example: same specific response for different proteins

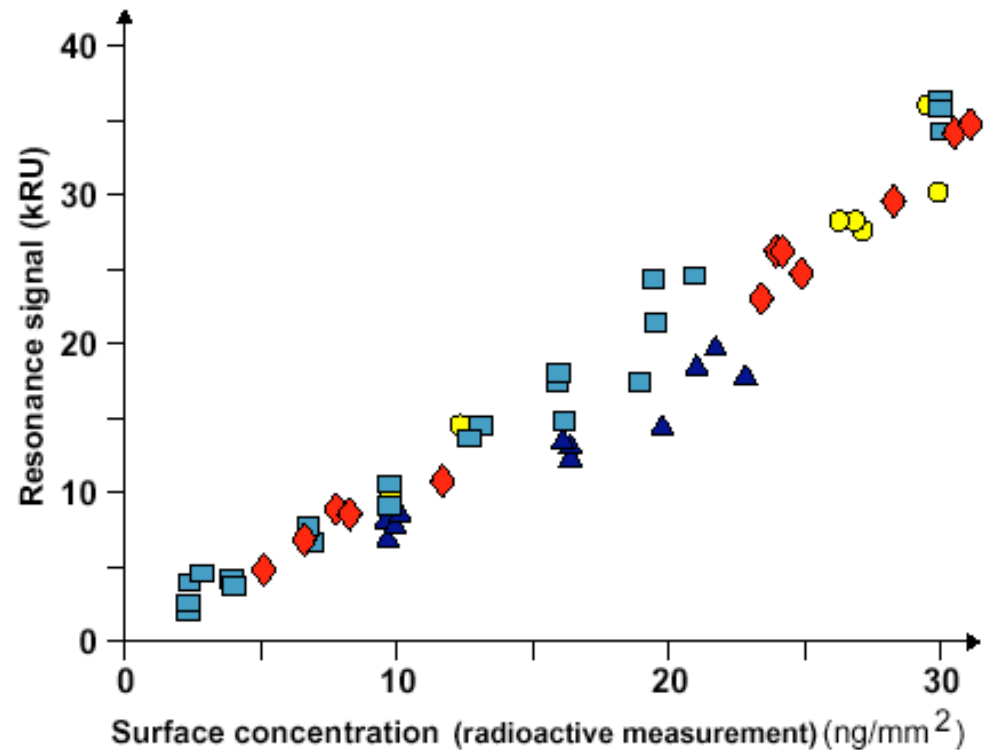

Adsorbate film thickness calculated as an average value

$$\Delta\Theta_o = c_1\Delta n + c_2\Delta d$$

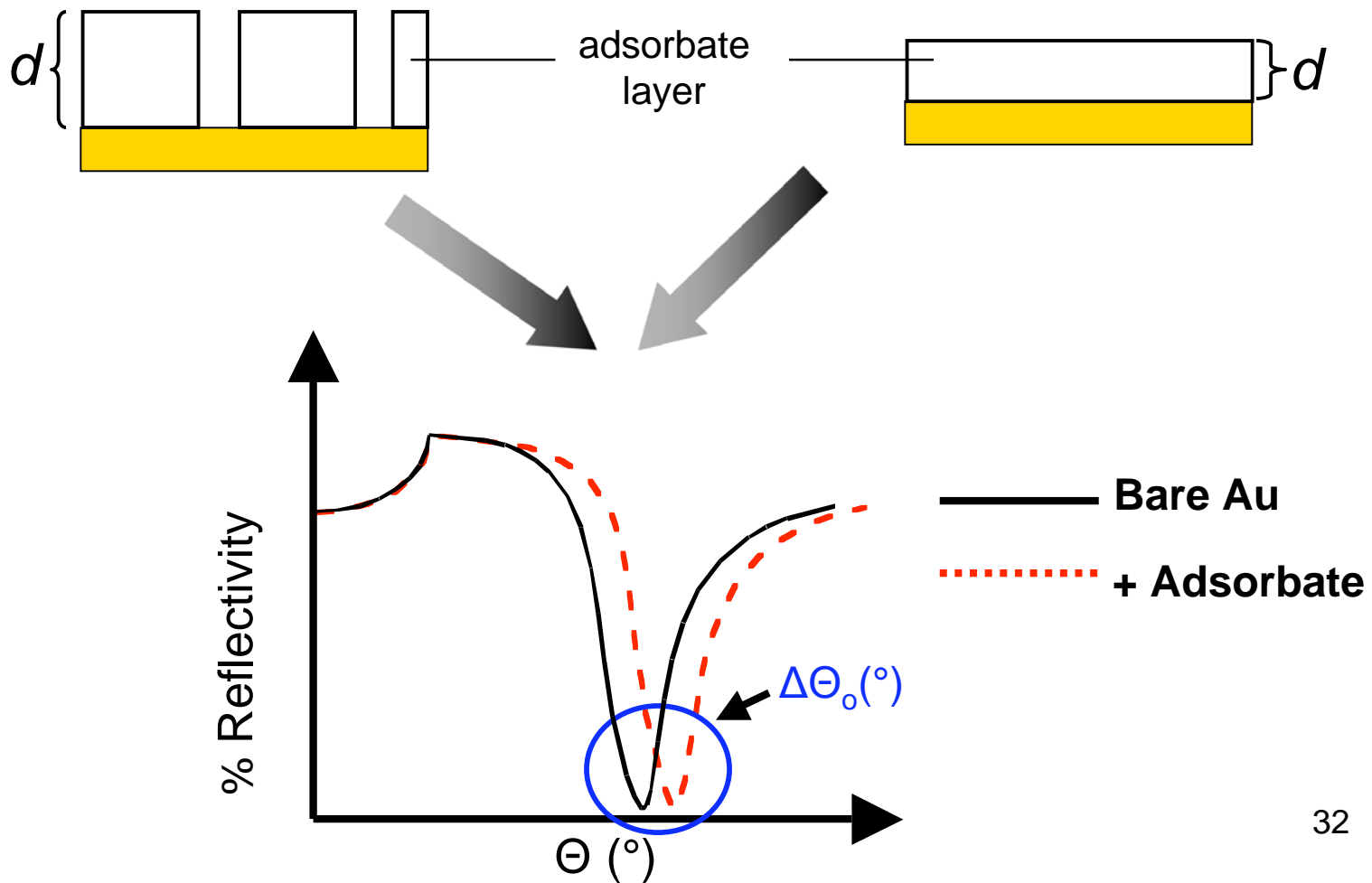

Modeling with Fresnel equations: Winspall software (freeware, Wolfgang Knoll, MPI-P)

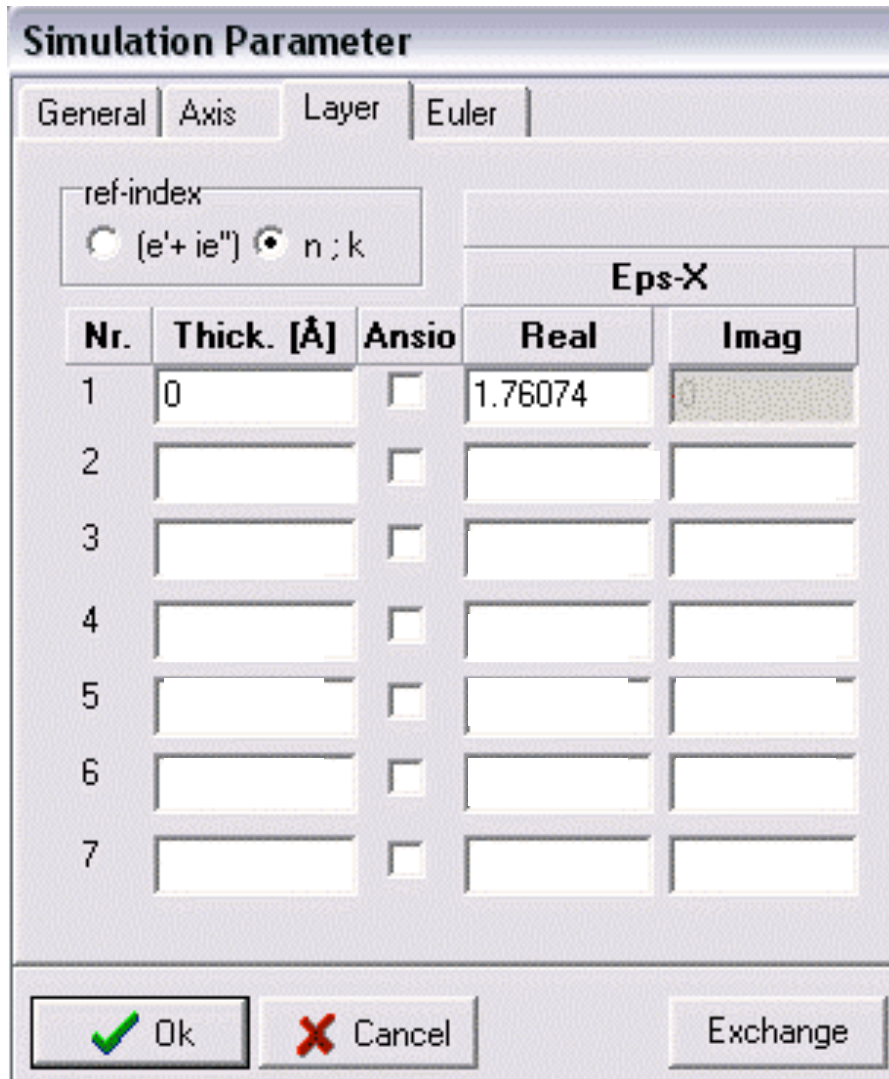

$$\Delta\Theta_0 = c_1\Delta n + c_2\Delta d$$

Prism

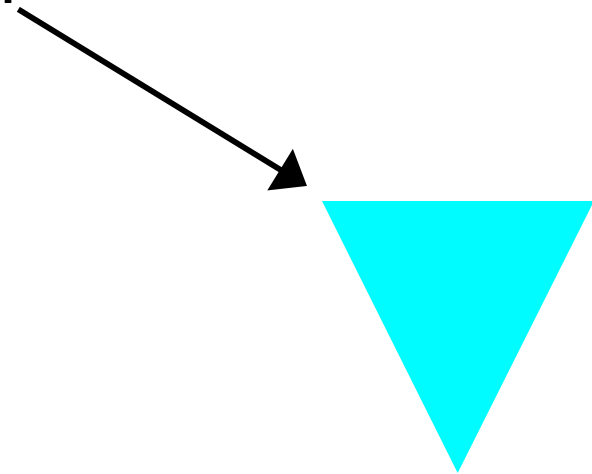

Modeling with Fresnel equations: Winspall

Simulation Parameter

General | Axis | Layer | Euler

ref-index
 (e'+ie'') n ; k

Nr.	Thick. [Å]	Ansiso	Eps-X	
			Real	Imag
1	0	<input type="checkbox"/>	1.76074	0
2	0	<input type="checkbox"/>	1.51474	0
3		<input type="checkbox"/>		
4		<input type="checkbox"/>		
5		<input type="checkbox"/>		
6		<input type="checkbox"/>		
7		<input type="checkbox"/>		

Ok Cancel Exchange

Prism
Glass Slide

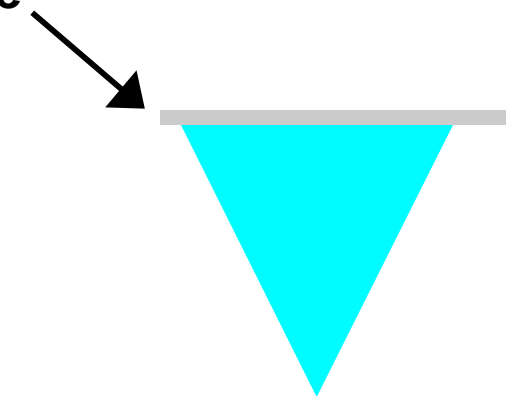

Modeling with Fresnel equations: Winspall

Simulation Parameter

General | Axis | Layer | Euler

ref-index
 (e'+ie'') n:k

Nr.	Thick. [Å]	Anisio	Eps-X	
			Real	Imag
1	0	<input type="checkbox"/>	1.76074	0
2	0	<input type="checkbox"/>	1.51474	0
3	12	<input type="checkbox"/>	2.7683	3.3065
4	480	<input type="checkbox"/>	0.1805	4.856
5		<input type="checkbox"/>		
6		<input type="checkbox"/>		
7		<input type="checkbox"/>		

Ok Cancel Exchange

Prism

Glass Slide

Ti

Au

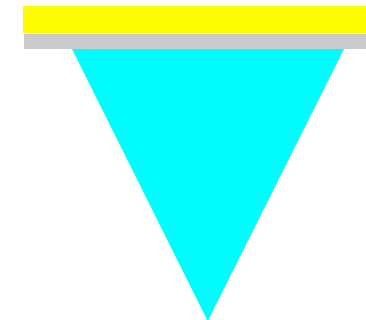

Modeling with Fresnel equations: Winspall

Simulation Parameter

General | Axis | Layer | Euler

ref-index
 (e'+ie'') n:k

Nr.	Thick. [Å]	Ansiso	Eps-X	
			Real	Imag
1	0	<input type="checkbox"/>	1.76074	0
2	0	<input type="checkbox"/>	1.51474	0
3	12	<input type="checkbox"/>	2.7683	3.3065
4	480	<input type="checkbox"/>	0.1805	4.856
5	18.9	<input type="checkbox"/>	1.464	0
6		<input type="checkbox"/>		
7		<input type="checkbox"/>		

Ok Cancel Exchange

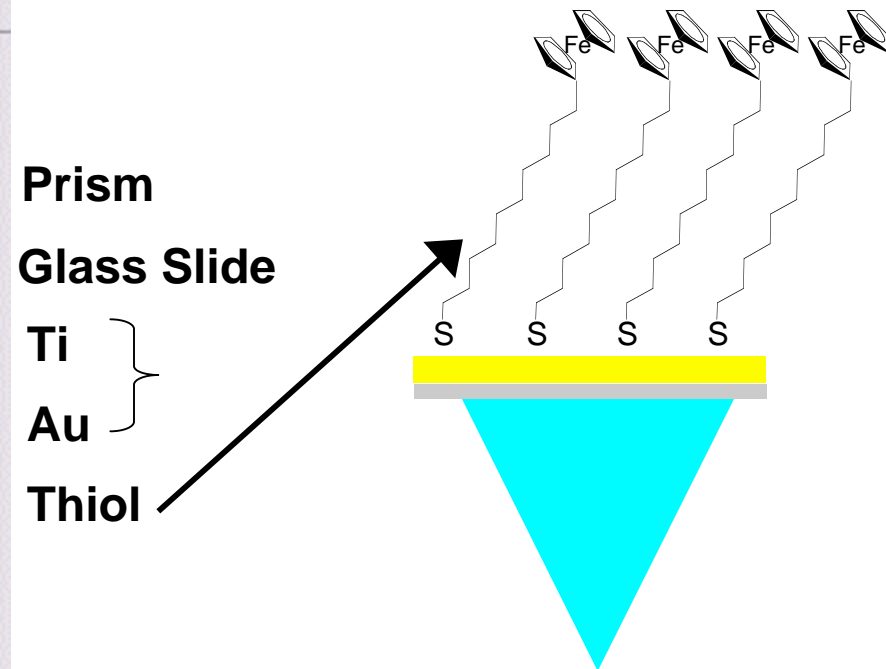

SPR profile fit

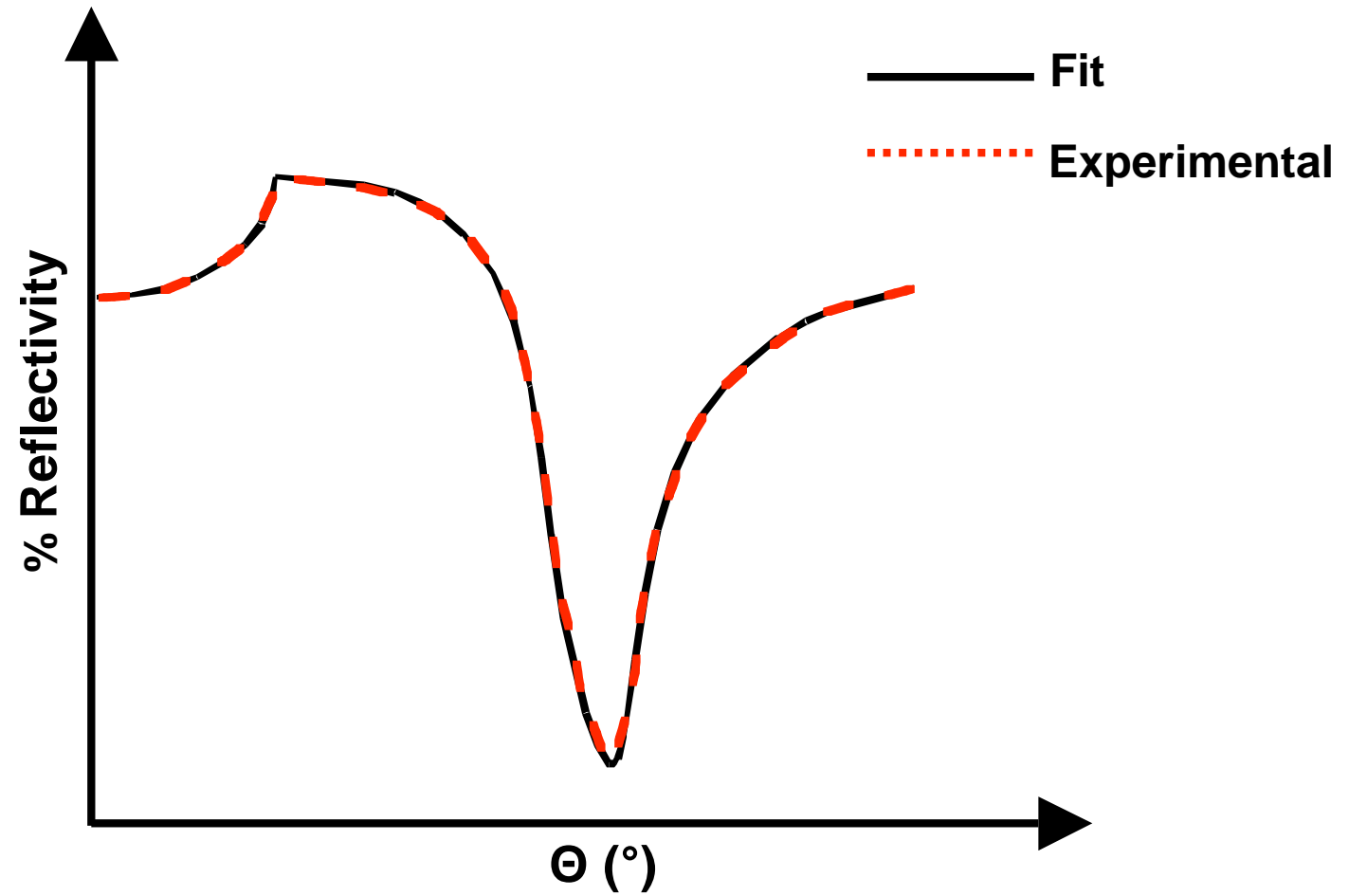

Calculation of surface concentration

- ❖ Determine adsorbate film thickness (d_{film}) from Fresnel fitting of the experimental angular reflectivity curve
- ❖ Determine the incremental change in the bulk refractive index with concentration of the adsorbate ($\partial n_{\text{adsorbate}} / \partial c$) using refractometry
- ❖ The surface excess (Γ / mol·cm⁻²) is calculated according:

$$\Gamma = d(n_{\text{film}} - n_{\text{solvent}}) \frac{1}{\partial n_{\text{adsorbate}} / \partial c}$$

n of hydrocarbon films \approx 1.45-1.50 (589-633 nm)

Binding kinetics

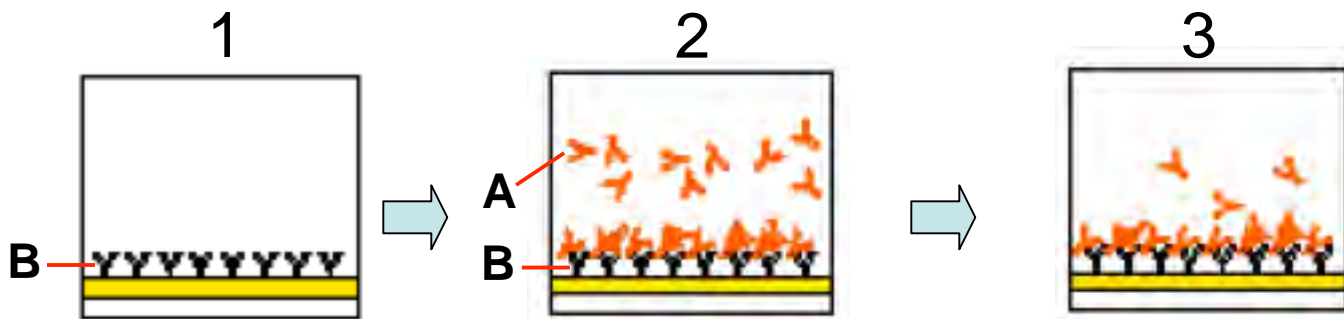
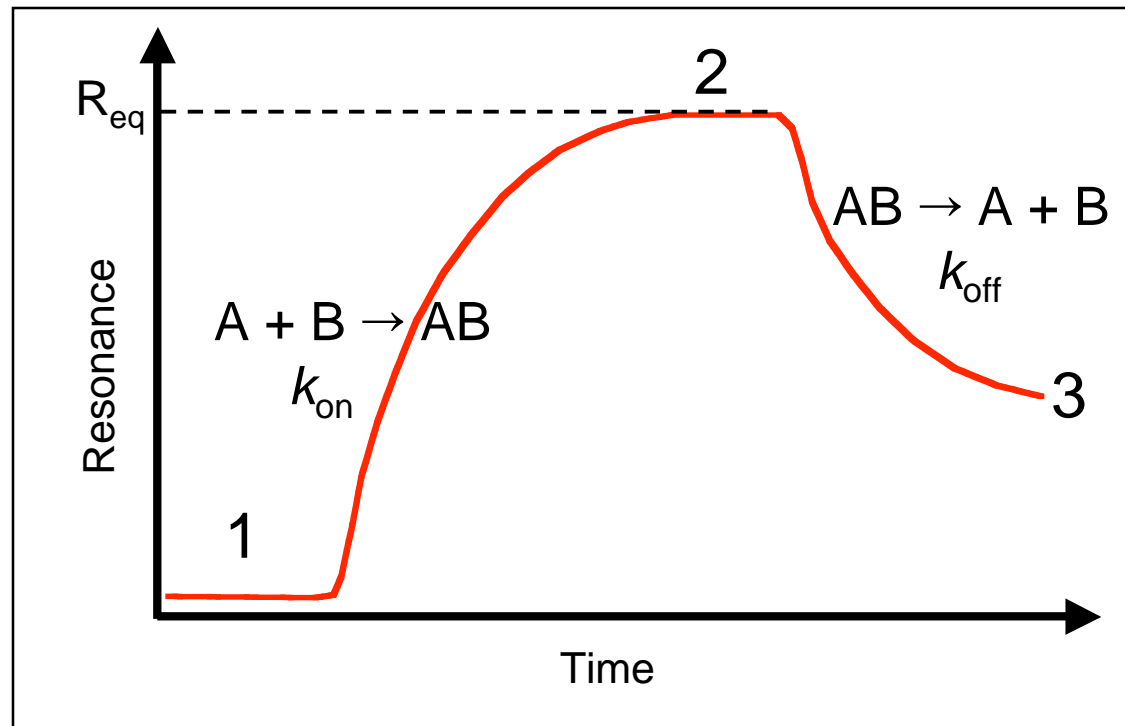

Simple binding kinetics

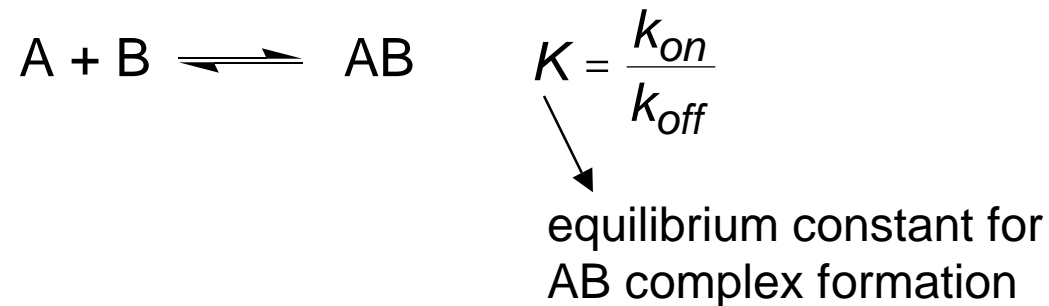

$$\frac{d[AB]}{dt} = k_{on}[A][B] - k_{off}[AB]$$

- If flow rate of A is sufficiently high, $[A] = a_0$
- We can also write $[B] = b_0 - [AB]$
- SPR signal $\propto [AB]$
- $R_{max} \propto b_0$ (measured if all B bound to A)

- We may write:

$$\frac{dR}{dt} = k_{on}a_0(R_{max} - R) - k_{off}R = k_{on}a_0R_{max} - (k_{on}a_0 + k_{off})R$$

- At equilibrium $R = R_{eq}$ and $dR/dt = 0$.

- It follows that: $R_{eq} = R_{max} \left(\frac{a_0K}{a_0K + 1} \right)$

- The value of K can be obtained from measurements of R_{eq} for a series of a_0

Mass transport considerations

- Do mass transport limitations impact the rate constants?
 - Yes, if binding rate $>$ diffusion rate
 - Introduces gradients
 - Myszka DG, et. al., “Extending the range of rate constants available from BIACORE: interpreting mass transport-influenced binding data”, *Biophys J* 1998, 75: 583-594.

SPR-based measurements

- Resonance angle shift
- **Imaging/microscopy**
- Wavelength shift (FT-SPR)

SPR imaging apparatus

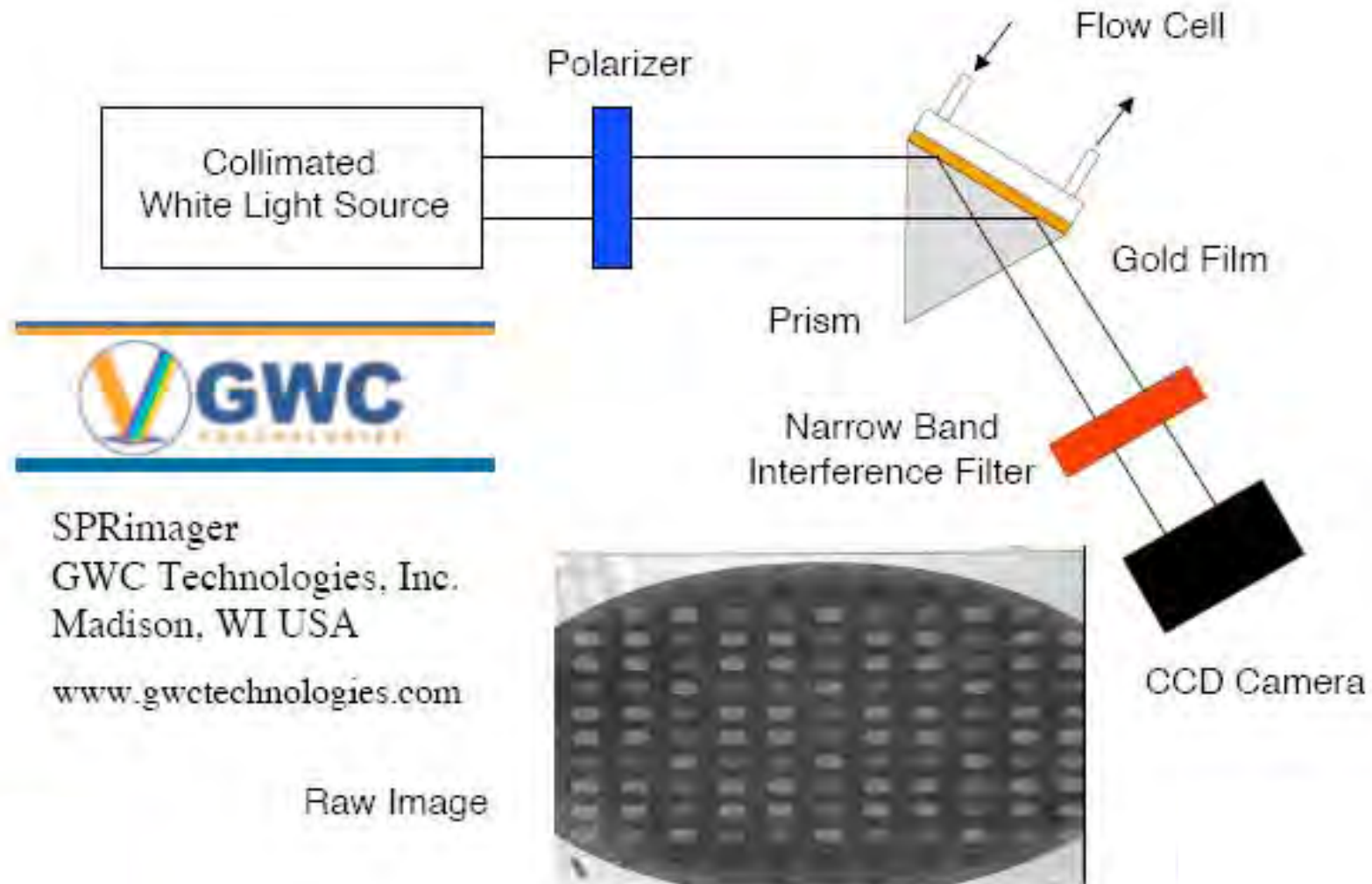

SPRImager
GWC Technologies, Inc.
Madison, WI USA
www.gwctechnologies.com

SPR Imaging

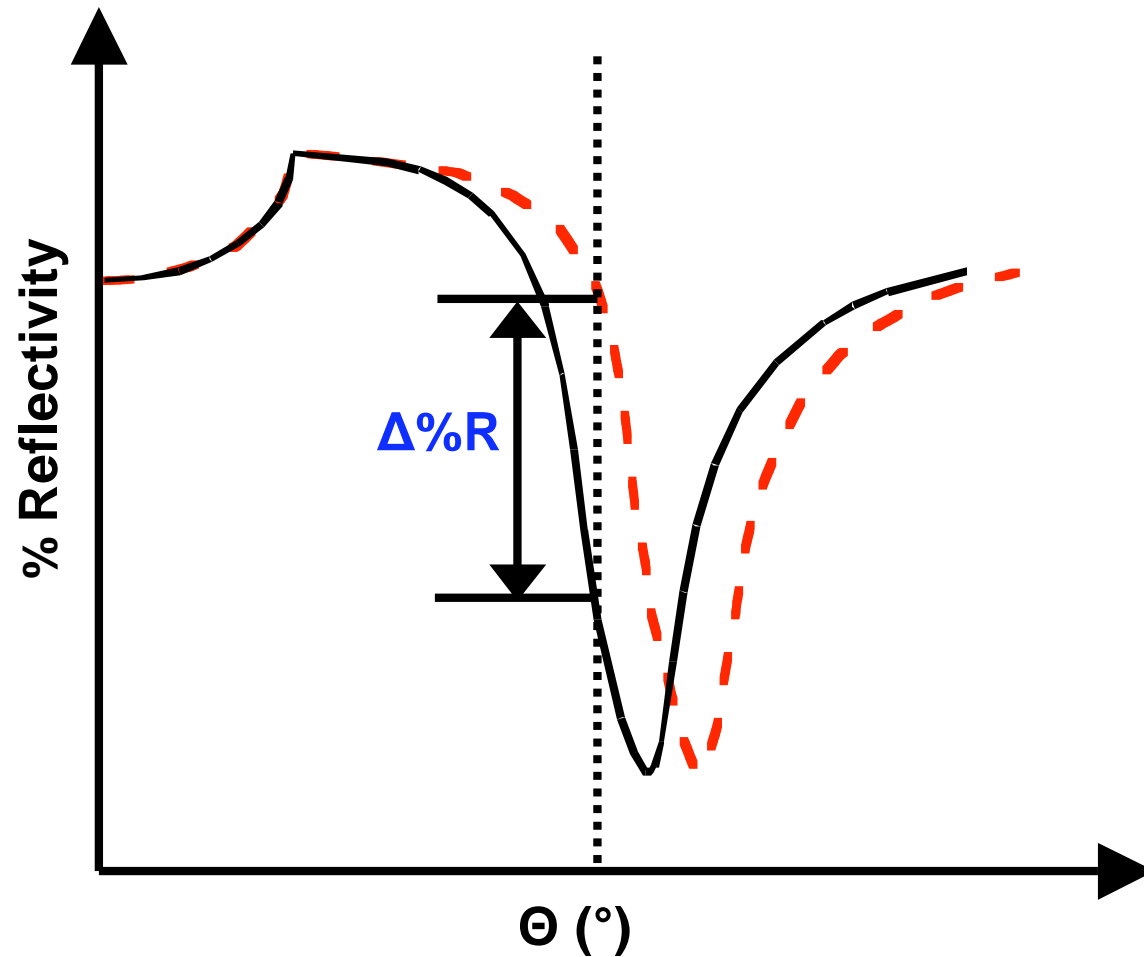

In SPR “imaging”, the reflectivity change, $\Delta\%R$, is determined by measuring the SPR signal at a fixed angle of incidence before and after selective molecular adsorption across a fixed surface.

SPR Imaging - Image processing

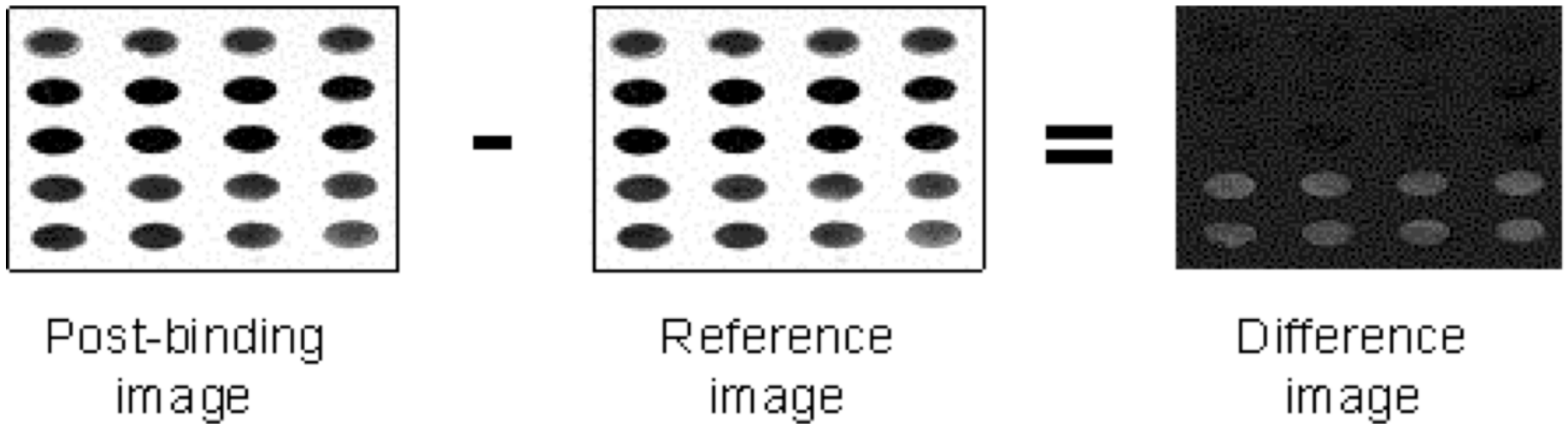

Z-resolution $\approx 1-2 \text{ \AA}$
X-Y resolution $\approx \text{microns}$

Problems of SPR

- Limited to choice of metal which results in SPR
- Sample preparation
 - Attaching probe to metal surface can prove difficult
- Non-specific interactions
 - Good news- Everything has an SPR signal!
 - Bad news- Everything has an SPR signal!
- Refractive index is temperature dependent

Future of SPR

- Combination of SPR with various surface analytical techniques:
 - Electrochemistry
 - Quartz Crystal Microbalance (QCM)
 - Ellipsometry
 - Scanning Probe Microscopy